

X GEN SERIES

AC/DC Single & Multi Output: 200 - 1200 Watts



Features

- Lowest profile 1U (40.40mm)
- IEC mains input connector
- 1.5V to 58V standard output modules
- All outputs fully floating and wide output adjustment
- Plug and Play power module architecture
 - allows fast/on site user configuration
 - individual output module control signals
- Universal input 85~264VAC with Power Factor Correction
- 4 slot slim line 200 - 600 watts package
- 6 slot 400 - 1200 watts package
- Full safety and EMC approvals
- **Medical** versions available
- Visual LED indicators

Specifications (cont)

ELECTROSTATIC DISCHARGE:	EN61000-4-2, level 4
RADIATED RFI:	EN61000-4-3, level 3
FAST TRANSIENTS:	EN61000-4-4, level 4
INPUT LINE SURGES:	EN61000-4-4, Class 4
VOLTAGE DIPS:	EN61000-4-11, (EN55024)
DIMENSIONS:	XL 4 Slot Chassis: 265 x 89 x 40.4mm XC 6 Slot Chassis: 265 x 127 x 40.4mm
WEIGHT:	XL 4 Slot Chassis: 1.2kg XL 6 Slot Chassis: 2.2kg

Specifications

INPUT VOLTAGE:	85-264VAC (120-380VDC)
INPUT FREQUENCY:	47-63Hz
OUTPUT POWER - XL: (4 Slot Chassis)	XLA = 200W, XLB = 400W, XLC = 600W
OUTPUT POWER - XC: (6 Slot Chassis)	XCA = 400W, XCB = 700W, XCC = 1000W, XCD = 1200W
INPUT CURRENT @ 90VAC:	XLA 4.0A, XLB, XLC, XCA 7.5A XCB 9.5A, XCC, XCD 11.5A
LOCKOUT VOLTAGE:	Unit will shutdown at low input approx 78VAC
OUTPUT MIN. LOAD:	Zero
LINE REGULATION:	±0.1% for 10% input variation
LOAD REGULATION:	±0.2% for 25-75% load step
RIPPLE & NOISE:	Typically 1% peak-peak. 20MHz Bandwidth
OVERVOLTAGE PROTECT:	1st Level: V set tracking, 2nd Level: Vmax. latching. Recycle input to restart
OVERCURRENT PROTECT:	Straight line current limiting set 110-120% I _{max} , with Hiccup activation when V falls to less than 30% of V _{out} nominal
REMOTE SENSE:	Except Xg7 and Xg8 modules. 0.5V max
OVERSHOOT:	2%
TURN ON DELAY:	From AC in/Enable Signal: 300ms/30ms
RISE TIME:	Module dependent typically 5ms
HOLD UP TIME:	Module dependent typically 20ms
ISOLATION:	Input - Output/Chassis: 3000VAC/1500VAC Output - Chassis: 500VDC
EFFICIENCY:	Module dependent typically 90%
SAFETY:	Approval to EN60950, UL1950
LEAKAGE CURRENT:	1.5mA at 250VAC 60Hz
INHIBIT/ENABLE:	Inhibit/Enable Signals on output modules - consult office
POWER GOOD:	Power Good Signals on output modules - consult office
BIAS SUPPLY:	Always ON. Current 250mA. Nominal 5.0VDC
OPERATING TEMP:	-20°C to 50°C at 100% load. Derate 2.5% per degrees C from 50-70°C
HUMIDITY:	5-95% RH non-condensing
SHOCK:	3000 Bumps, 10G (16ms half sine)
VIBRATION:	1.5G (10-200Hz)
RELIABILITY:	Power modules: one failure per million hours Power Pacs: half failure per million hours
EMC CONDUCTED:	EN55011, EN55022 level B
EMC RADIATED:	EN55011, EN55022 level B
HARMONICS:	EN61000-3-2
FLICKER & FLUCTUATION:	EN61000-3-3

Application notes and further technical information available from our website: www.amtex.com.au



X GEN SERIES

AC/DC Single & Multi Output: 200 - 1200 Watts

Output Power Module Selection

Output Module P/N	Output V	Output A	Voltage Range	No. of Slots	Power W
1	2.5V	50A	1.5~3.6V	1	125W
2	5.0V	40A	3.2~6.0V	1	200W
3	12.0V	20A	6.0~15.0V	1	240W
4	24.0V	10A	12.0~30.0V	1	240W
5	48.0V	6A	28.0~58.0V	1	288W
7	24.0V	5A	5.0~28.0V	1	120W
8	V1 = 24V V2 = 24V	3A 3A	5.0~28.0V 5.0~28.0V	1 1	72W 72W

Model Configuration:

1. Use the output module rating to configure the V outputs required and current rating.
2. Any number of different modules can be connected in series to obtain the desired output voltage.
3. Any number of the same module type can be connected in parallel for increased output current for specific V out.
4. Then select the appropriate **4 slot** or **6 slot** chassis and appropriate Power Level Front End.

MODEL EXAMPLE

XCA2245

6-slot 400W package:
5V, 5V, 24V, 48V, (nominal)



X = Series

Power:

- LA = 200W 4 slot
- LB = 400W 4 slot
- LC = 600W 4 slot
- CA = 400W 6 slot
- CB = 700W 6 slot
- CC = 1000W 6 slot
- CD = 1200W 6 slot

Output Module Type

- 1 = 2.5V
- 2 = 5V
- 3 = 12V
- 4 = 24V
- 5 = 48V
- 7 = 24V
- 8 = Dual 24V

Factory Allocated

4 SLOT CHASSIS

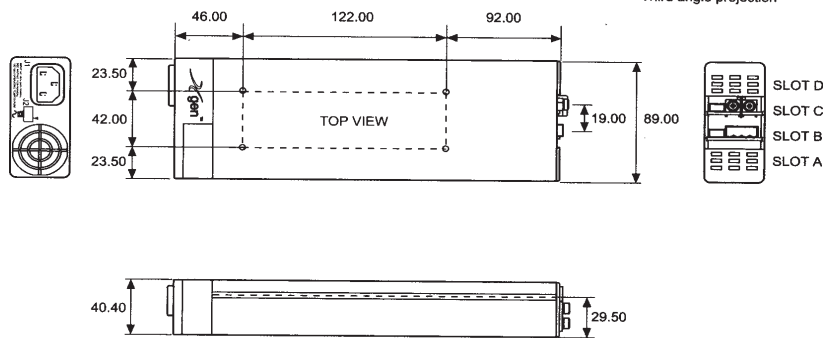

All Dimensions in mm
4-OFF M4 Mounting Holes on the Base
Max screw penetration is 6mm from Base

6 SLOT CHASSIS

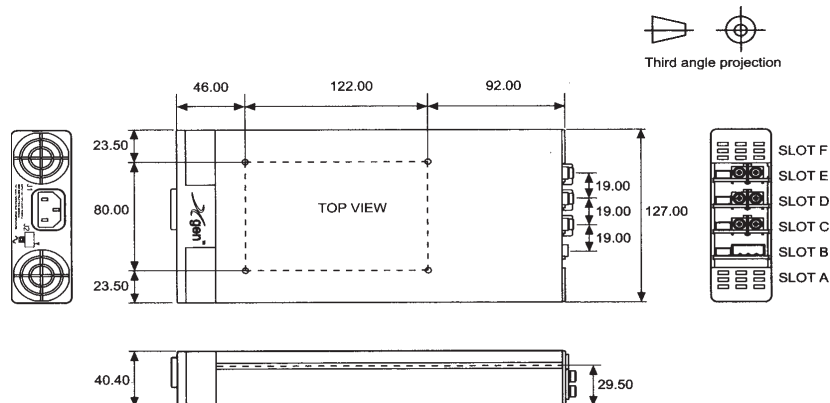

All dimensions in mm
4 M4 Mounting holes on the Base
Max screw penetration is 6mm from Base

Voltage Adjustment - Local

The multi-turn potentiometer that adjusts each output within the specified range may be accessed via the output panel of the power supply. Clockwise rotation increases output voltage. Resolution is approximately 5% of nominal voltage (V_{nom}) per turn.

Voltage Adjustment - Remote (resistive / electronic)

The output voltage may be adjusted or trimmed by means of an external resistor or potentiometer network connected to the V_{trim} pin. Linear Electronic programming is also possible and may be implemented according to the formula $V_{out} = K V_{control}$. See Xgen series Designers' Manual for full details.

Paralleling

To achieve increased current capacity, simply parallel outputs using the standard parallel links. Excelsys 'wireless' sharing ensures that current hogging is not possible.

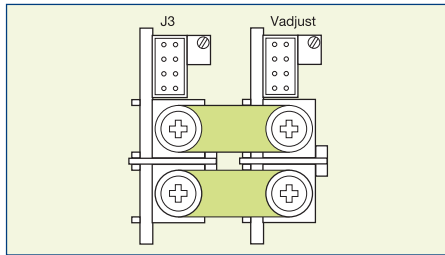

Standard parallel links can be supplied. To order, please use part number XP1.

Seriesing

To achieve increased output voltages, simply series outputs using standard series links, paying attention to the requirements to maintain SELV levels if required in your system.

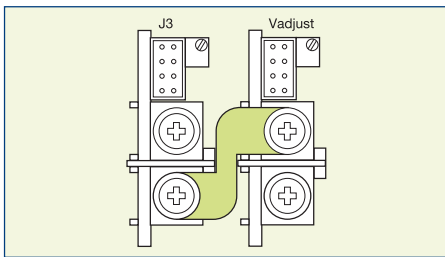

Standard serial links can be supplied. To order, please use part number XS1.

Remote Sensing

When the load is remote from the power supply, the remote sense pins may be used to compensate for drops in the power leads. Where the power cabling contributes significant dynamic impedance, see Xgen series Designers' Manual.

Bias Voltage

A SELV isolated 5V (always on) bias voltage rated at 250mA is provided on J2 to facilitate miscellaneous control functions.

Current Limit Adjustment

The output current limit setting may be adjusted (downwards only) by means of an external resistor connection to the I trim pin.

Inhibit/Enable

Inhibiting may be implemented either globally or on a per module basis (*powerPac* or *powerMod* inhibiting). Reverse logic (Enabling) may also be implemented, see Xgen series Designers' Manual.



Option: P/N: **XE1**

Converters IEC socket connection (AC Input) to screw terminal Connector

AC Fail

Open collector signal indicating that the input voltage has failed or is less than 80Vac. This signal changes state giving 5mS of warning before loss of output regulation. See Xgen series Designers' Manual for full specifications.

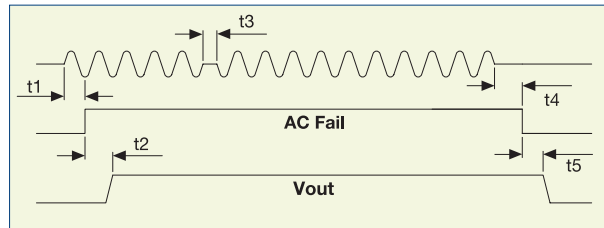

Temperature Alarm (Option 01)

Open collector signal indicating excessive *powerPac* temperatures due to fan failure or operation beyond ratings. This signal is activated at least 10ms prior to system shutdown.

Fan Fail (Option 01)

Open collector signal indicating that at least one of the system fans have failed. This does not cause system shutdown.

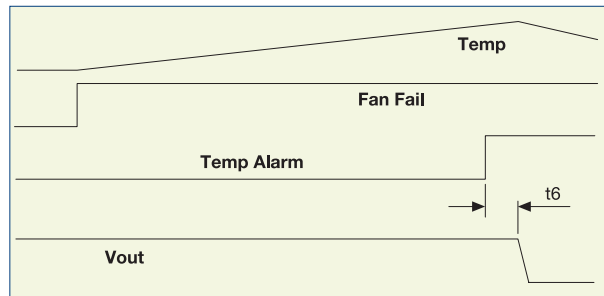

Power Good

Opto-isolated output signal indicates that the *powerMod* is operating correctly and output voltage is within normal band. Opto transistor ON = Good.

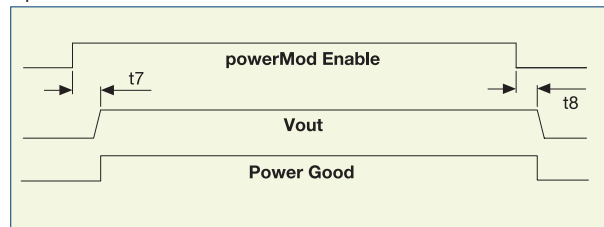

Indication LEDs

Each *powerMod* has a visual indicator to identify that it is operating within normal ratings. Very useful for system diagnosis.

Signal Connector Pinout

Pin	J2 (<i>powerPac</i>)	J3 (<i>powerMod</i> TYPE A)**	J3 (<i>powerMod</i> Type B)**
1	common	+sense	+pg (V2)
2	+5V bias	-sense	-pg (V2)
3		V trim	inhibit (V2)
4	ac fail	I trim	common (V2)
5	fan fail*	+inhibit/enable	+pg (V1)
6	global enable	-inhibit/enable	-pg (V1)
7	temp alarm*	+power good	inhibit (V1)
8	global inhibit	-power good	common (V1)

*Option 01 only

**See individual *powerMod* datasheets



Optional Signals Connector Cable: P/N: **XGEN-J2-J3**

XGEN: Connectors and Pin-Outs

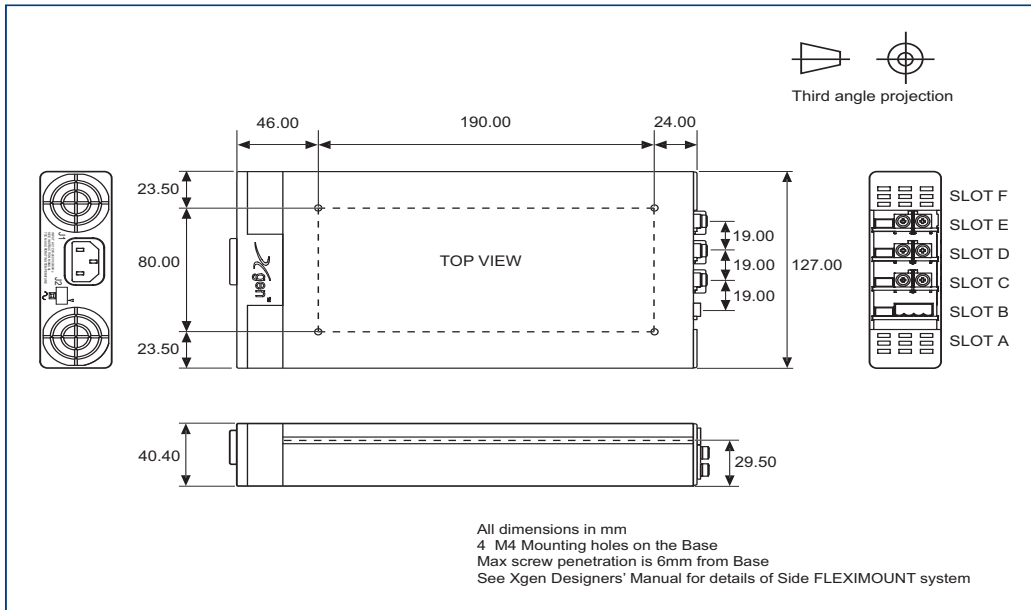

Output: **powerMod Type XG1-XG7**

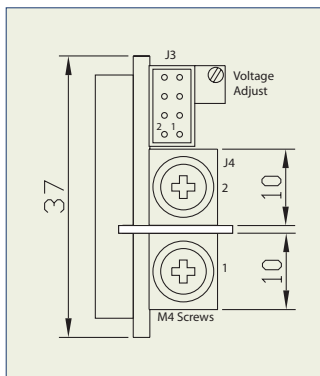

powerMod Type XG-8

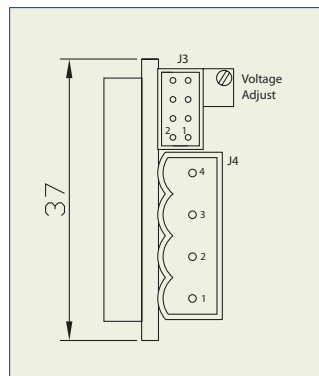

J3: **powerMod Signal Connector**

Pin	Type A	Type B
1	+Sense	+PG (V2)
2	-Sense	-PG (V2)
3	Vtrim	Inhibit (V2)
4	Itrim	Common (V2)
5	+Inhibit/Enable	+PG (V1)
6	-Inhibit/Enable	-PG (V1)
7	+Power Good	Inhibit (V1)
8	- Power Good	Common (V1)

Mating parts:
Housing Molex p/n 51110
Crimp Terminal Molex p/n 50394

J4: **powerMod Output Connector**

Pin	Type XG1-XG7	Type-XG8
1	-Vout	- V2
2	+Vout	+V2
3		-V1
4		+V1

Type A : M4 Screw Terminals

Type B : Mating part:

Molex - xxxxxxxxxx

Phoenix - xxxxxxxxxx