

PAH-S48 SERIES

APPLICATION NOTES

LAMBDA 
DENSEI-LAMBDA

POWER MODULE

DRAWING NO. : PA548-04-01B		
NLS R&D		
PREPARED	CHECKED	APPROVED
<i>YEA.</i> 1/12/99.	<i>[Signature]</i> 1/12/99	<i>[Signature]</i> 1/12/99
DATE ISSUE : 1/12/99		

DENSEI-LAMBDA

PAH-S48 SERIES

Before Using This Power Module

Pay attention to all warnings and cautions before using this unit. Incorrect usage could lead to an electrical shock, damage to the unit, or a fire hazard. Be sure to read below **warning** and **caution** before using the power module.

Warning

- ❑ Do not touch heatsink and case which may be hot.
- ❑ Do not open the case and touch the internal components. They may have high temperature or high voltage which may get you in electrical shock or burned.
- ❑ When the unit is operating, keep your hands and face away from the unit. You may get injured by an accidents.

Caution

- ❑ Confirm connections to input/output terminals and signal terminals are correct as indicated in the instruction manual.
- ❑ Attach a fast blow type external fuse to each module to ensure safety operation and to acquire each safety standard approval.
- ❑ This power module is designed for professional installation within an end user equipment.
- ❑ Use isolated voltage by reinforced insulation at primary power supply or double insulation as input power source.
- ❑ The output from this power module must be considered as an energy hazard (> 240VA power and 2V voltage) and must not be accessible to an end user. End equipment manufacturers must provide protection against inadvertent contact with the output terminals on this product by a service engineer or by service engineer dropping a tool into them.
- ❑ The application circuits and their parameter are for reference only. Be sure to verify effectiveness of application circuits and their parameters before finalizing circuit design.
- ❑ The information in this document is subject to change without notice. For actual design-in, please refer to the latest publications of data sheet, etc., for the most up-to-date specifications of the unit.
- ❑ No part of this document may be copied or reproduced in any form or by any mean without prior written consent of Densei-Lambda.

Terminal Pin Configurations

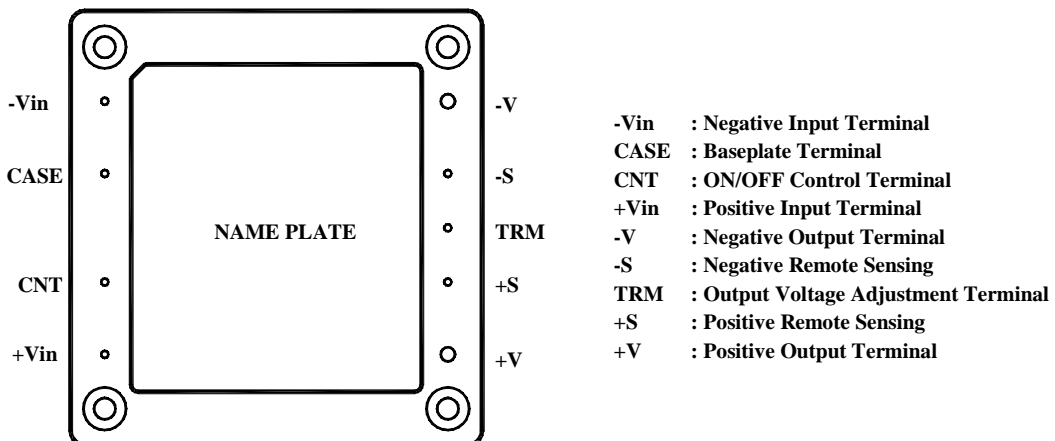

PAH-S48 SERIES APPLICATION NOTES

FEATURES:

- High power density : 73W/inch³
- High efficiency : 84% (V_O=5V)
- Operating baseplate temperature : -40°C ~ +100°C
- Safety : UL1950, EN60950, CSA950, CE Marked
- Input Voltage : 36V ~ 76VDC
- Over temperature protection : auto recovery
- Over voltage protection : reset with CNT pin
- Small size : 2.40in X 2.28in X 0.5in

OPTION :

- Remote On / Off control logic (Negative logic[standard], Positive logic[option /P])
- Over voltage protection (Manual restart[standard], Auto restart[option /V])

Description

PAH-S48 SERIES power modules are high efficiency and high power density dc-dc converters. It is suitable for wide range of application such as EDP equipment, workstations and telecommunications equipments.

The mechanical designs of these modules make it easy for heat dissipation as well as easy mounting on any equipment. An additional advantage to these power modules is that the OVP can be reset by using the control pin, CNT instead of recycled the input power as in the conventional method; which is also possible.

The standard 50W ~ 150W modules are available in seven types of output voltage; 2.5V, 3.3V, 5V, 12V, 15V, 24V and 28V. For 200W module, there are only four types of output voltage; 12V, 15V, 24V and 28V. They come with remote sensing, output adjustable range, over current protection, over voltage protection, over temperature protection and remote ON/OFF. With all these features, the power modules are flexible to be use in any power supply applications.

PAH-S48 SERIES APPLICATION NOTES

CONTENTS :-

1. External Components
2. Input Voltage Range
3. Output Voltage Adjust Range
4. Output Ripple & Noise Measurement Method
5. Maximum Line Regulation
6. Maximum Load Regulation
7. Brownout
8. Over Current Protection
9. Over Voltage Protection
10. Thermal Protection
11. Remote Sensing
12. ON/OFF Control (CNT)
13. Series Operation
14. Operation Temperature
15. Operation Humidity
16. Storage Temperature
17. Storage Humidity
18. Cooling Method
19. Baseplate Temperature vs. Output Regulation
20. Withstand Voltage
21. Isolation Resistance
22. Vibration
23. Shock
24. Block Diagram. Sequence Chart

BASIC CONNECTION

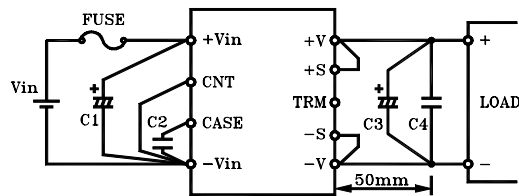

Note : This diagram is for Negative Logic "ON/OFF" Option.

1. External Components

The table below shows the recommended values for the above external components.

Item	Model	2.5	3.3	5	12	15	24	28
F1	200S				250V 15A			
	150S	250V 10A						
	100S	250V 7A						
	75S	250V 5A						
	50S	250V 5A						
		(UL approved and fast acting)						
C1*	All	Electrolytic capacitor : 100V 33uF						
C2	All	Ceramic capacitor : 2KVAC 4700pF						
C3*	200S				1000 uF	1000 uF	470 uF	470 uF
	150S	2200 uF	2200 uF	2200 uF	470 uF	470 uF	220 uF	220 uF
	100S							
	75S							
	50S							
C4	All	Film capacitor : 50V 1uF						

- * :-
- (1) The above value is for operating temperature range from -20°C to 100°C.
 - (2) For -40°C ~ 100°C range, change C1 to ceramic type of capacitor and use 2 capacitors for C3.
 - (3) Use low ESR type E-Cap for C1 and C3 such as KME series for C1 and LXY series of Nippon Chemi-Con for C3.

PAH-S48 SERIES module is not internally fused. To ensure safe operation and to receive each safety standard approval, please connect an external fuse, F1 as shown in the diagram above.

Input capacitor C1 is recommended to stabilize the module when the module is powered from a high impedance source.

Capacitor C2 is used to absorb noise coming from the module itself. This capacitor will also help the EMI performance of the module.

The function of capacitor C3 is to reduce the output ripple of the power module whereas the capacitor C4 is to reduce high frequency noise that is produced by the module.

If in any application that an input reversal connection is possible, a protective diode that is connected across +Vin and -Vin is recommended.

2. Input Voltage Range

The operating input voltage range of PAH-S48 SERIES is 36 ~ 76VDC. The maximum allowable input ripple voltage (V_{rpl}) is 4V. Any ripple that exceeds this value might cause the module to become unstable.

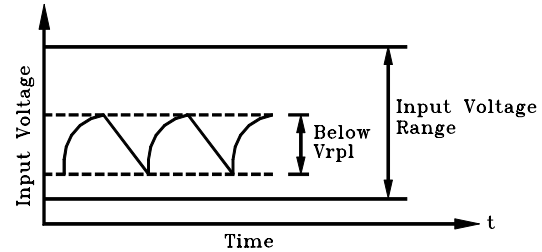

3. Output Voltage Adjust Range

The output voltage of power module can be adjusted by connecting an external resistor (R_{adj}) between the TRIM pin and either the +S or -S pins. With an external resistor (R_{adj}) between TRIM pin and -S pin, output voltage will decrease as shown in diagram below.

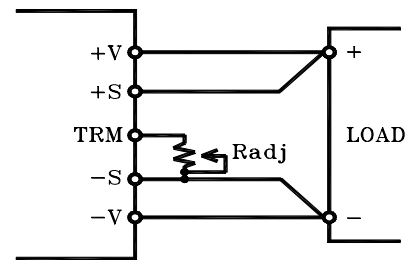

The equation shown below determines the required external resistor (R_{adj}) value to obtain a percentage output voltage change of $\Delta\%$.

$$R_{adj}(\text{down}) = \left(\frac{100\%}{\Delta\%} - 2 \right) \text{k}\Omega$$

The graph shown below is the external resistor (R_{adj}) value against a percentage output voltage change of $\Delta\%$.

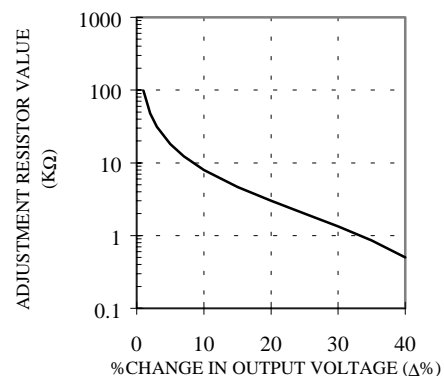

If the external resistor (R_{adj}) is connected between the TRM pin and +S pin, the output voltage will increase. Diagram shown below is the output voltage trim up connection.

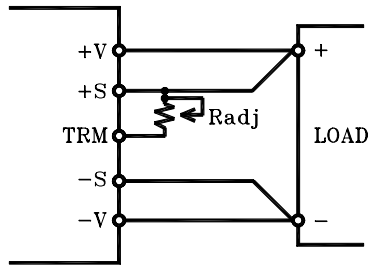

The equation shown below determines the required external resistor (R_{adj}) value to obtain a percentage output voltage change of $\Delta\%$.

$$R_{adj}(up) = \left(\frac{V_o(100\% + \Delta\%)}{1.225\Delta\%} - \frac{(100\% + 2\Delta\%)}{\Delta\%} \right) k\Omega$$

V_o = Nominal output Voltage.

The graph shown below is the external resistor (R_{adj}) value against a percentage output voltage change of $\Delta\%$.

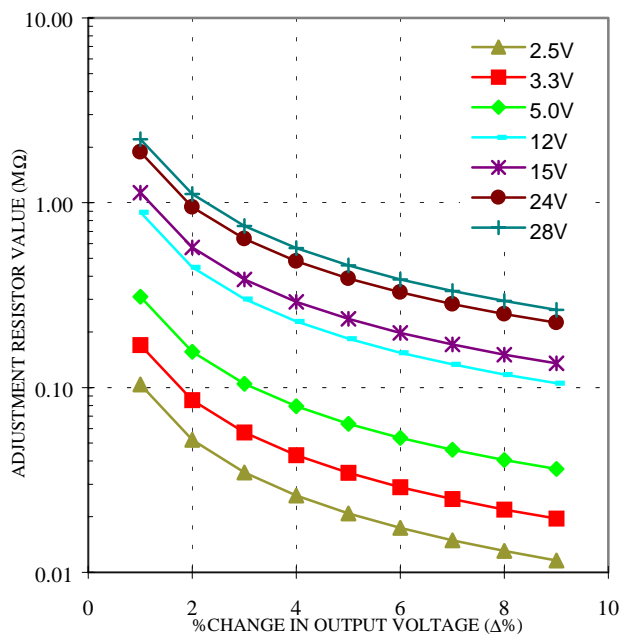

If the output voltage is raised above its nominal value, the output current needs to be derated to a value such that the output power does not exceed the maximum output power specified in the specification sheet. In addition to that, there is also

a limitation to the input voltage range for the 5V version only which is as shown below.

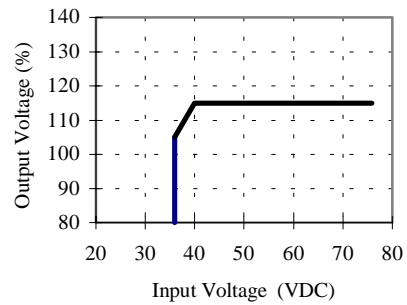

4. Output Ripple & Noise Measurement Method

The method for output ripple and noise are based upon EIAJ RC-9002A. Upon measurement of the ripple voltage, make sure that the oscilloscope probe leads are not too long.

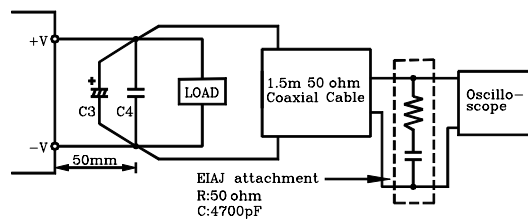

5. Maximum Line Regulation

Maximum line regulation is the maximum output voltage change when the input voltage is slowly varied within the input voltage range. The measurement point for the input and output voltage are $\pm V_{in}$ and $\pm S$ (sense point) respectively.

6. Maximum load regulation

Maximum load regulation is the maximum output voltage value change when varying the load current slowly within the standard output current range. The measurement point for the input and output voltages are $\pm V_{in}$ and $\pm S$ (sense point) respectively.

7. Brownout

There will be output voltage overshoot during brown-out (momentary input line off) condition.

8. Over Current Protection

The PAH-S48 SERIES is equipped with an over current protection circuit. When the short or overload condition is removed, the output will automatically recover. This setting is fixed and cannot be varied externally. If the short or overload condition continues, the power module could be damaged due to the heat condition.

9. Over Voltage Protection

There are 2 types of over protection method available for the PAH series. In the standard model, a latching shutdown method is adopted. For this method there are two ways to reset the power module after OVP protection triggers. They are by (i) giving a pulse to the control pin or (ii) recycling the input voltage. In the /V optional model, the power module will shutdown after OVP protection triggers but will recover automatically when over voltage is removed.

10. Thermal Protection

The PAH-S48 SERIES have a thermal protection circuit that sense the baseplate temperature between the range of 105°C to 130°C for an over temperature condition. Under a condition where the ambient temperature or the power module internal temperature rises excessively, the thermal protection circuit will shut down the power module. The power module will recover automatically when the baseplate temperature cools down.

11. Remote Sensing

The PAH-S48 SERIES is equipped with remote sensing terminals, which compensate for the voltage drops between the power supply output terminals and the load terminals. Remote sensing should be performed at the load. When remote sensing is not required (local sensing), short the +S with the +V terminal, and the -S with the -V terminal. The compensation range should be kept so that the output voltage is within the output voltage range and the maximum power is not exceeded. For long connections and noise sensitive environments, shielded wires are recommended to minimize noise pickup on the output leads.

Remote Sensing in Use

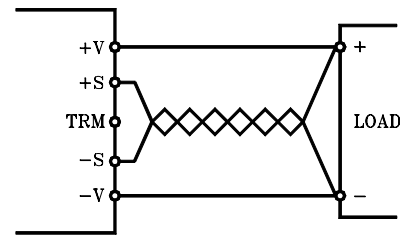

Remote Sensing not in Use

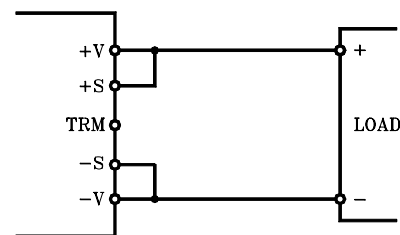

12. ON/OFF Control (CNT)

Without turning the input supply on and off, the output can be enabled and disabled using this function. This control circuit is on the input side of the power module; CNT terminal pin. There are two options available in this function, which are Negative Logic and Positive Logic. In the standard model where Negative Logic is used, the power module will turn on when CNT terminal pin is shorted to $-V_{in}$ or a low logic voltage is provided. The power module will turn off when CNT pin is open or Logic high is provided. In the /P optional model where Positive logic is used, the control method is vice versa to the Negative Logic.

Below tables summarizes the CNT levels and output states with different logic types.

a) Negative Logic: (Standard model)

CNT Level to $-V_{in}$	OUTPUT
H (more than 2.0V) or Open	OFF
L (less than 1.0V) or Short	ON

b) Positive Logic: (/P option)

CNT Level to $-V_{in}$	OUTPUT
H (more than 2.0V) or Open	ON
L (less than 1.0V) or Short	OFF

The maximum CNT pin voltage when it is opened is 7V. The maximum low logic sourcing current is 0.6mA. When using long wiring, attach a 0.1 μ F capacitor between the CNT and $-V_{in}$ terminals.

Remote ON/OFF control can also be exercised by opening or closing the contacts of a switch or relay, or by operating a transistor as a switch in series with the CNT terminal.

Standard remote ON/OFF control circuit is provided in the primary circuit. For secondary control, isolation can be achieved through use of an opto-coupler or relay.

CNT Connection Method

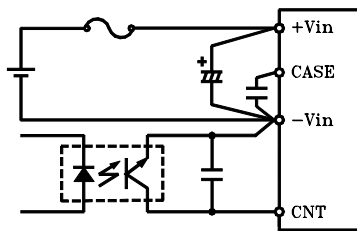

2) +/- Output Series Operation

When the load on the positive side is isolated from the load on the negative side, the following connection hookup is recommended. Bypass diodes are not needed when operate in this mode.

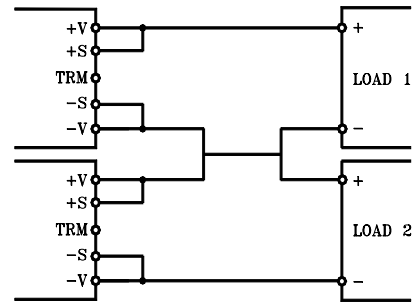

13. Series Operation

All PAH-S48 SERIES modules allow series operation with any combination of output voltages. Please contact us for maximum number of connections possible.

1) Series Operation for High Output Voltage Applications

When using PAH-S48 SERIES modules in a high output voltage configuration external bypassing diodes need to be connected to either module.

- a. Peak Reverse Voltage
VRRM > 2x the power module output voltage
- b. Average Output Current
Io > Twice the power module output current
- c. Forward Voltage
VF = Minimum (Schottky Barrier Type, etc)

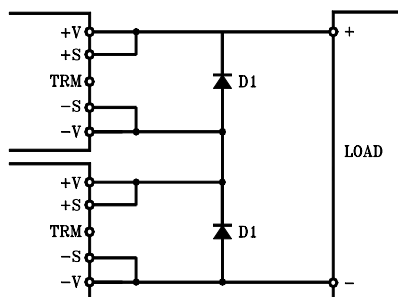

14. Operation Temperature

The baseplate temperature range for PAH-S48 SERIES is from -40°C to 100°C.

15. Operation Humidity

Avoid the buildup of condensation on or in the power module.

16. Storage Temperature

Please note that sudden temperature changes can cause condensation buildup, and other harmful affects to each terminal solder.

17. Storage Humidity

High temperature and humidity can cause the terminals on the module to oxidize. The quality of the solder will become worse.

18. Cooling Method

The operating temperature is specified by the baseplate temperature. Various cooling methods are possible such as using heatsink or chassis of the equipment. If the temperature is very high, fan is recommended.

19. Baseplate Temperature vs. Output Regulation

This is the output voltage change ratio when varying the baseplate operation temperature.

20. Withstand Voltage

The power module is designed to withstand 1.5kVAC between the input to the baseplate and input to output for 1 minute. In the case that the withstanding voltage is tested in the incoming goods test, etc., please set the limit of the test equipment to 20mA. The applied voltage must be increased gradually from zero to the testing value, and then decreased gradually at shutdown. Do not use a timer where a pulse of several times the applied voltage can be generated. This could cause damage to the module. Be sure to short all the input and output pins as shown below.

Input ~ Baseplate

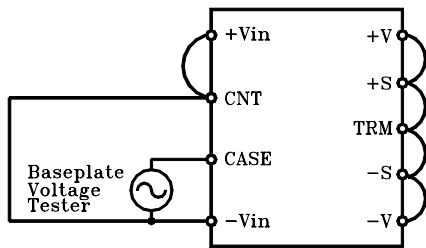

1.5kVAC 1 min. (20mA)
 Note :- Please be sure to short all the input & output pins as shown above.

Input ~ Output

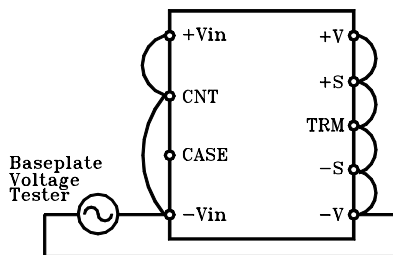

1.5kVAC 1 min.(20mA)
 Note :- Please be sure CASE is not shorted to any pins.

21. Isolation Resistance

The isolation resistance is more than 100MΩ at 500VDC when tested with a DC isolation tester between the output and the baseplate. Make sure that during testing, the isolation testers do not produce a high pulse when the applied voltage is varied. Ensure that the tester is fully discharged after the test.

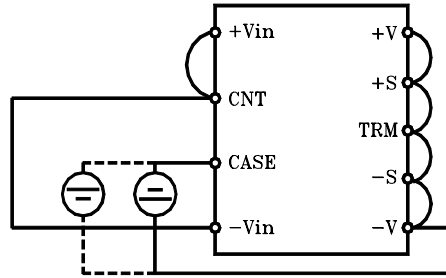

22. Vibration

Please refer to the power module mounting in the PAH-S48 series Handbook in order to achieve vibration level stated in the specification.

23. Shock

Value for the conditions of our shipping and packaging.

24. Block Diagram . Sequence Chart

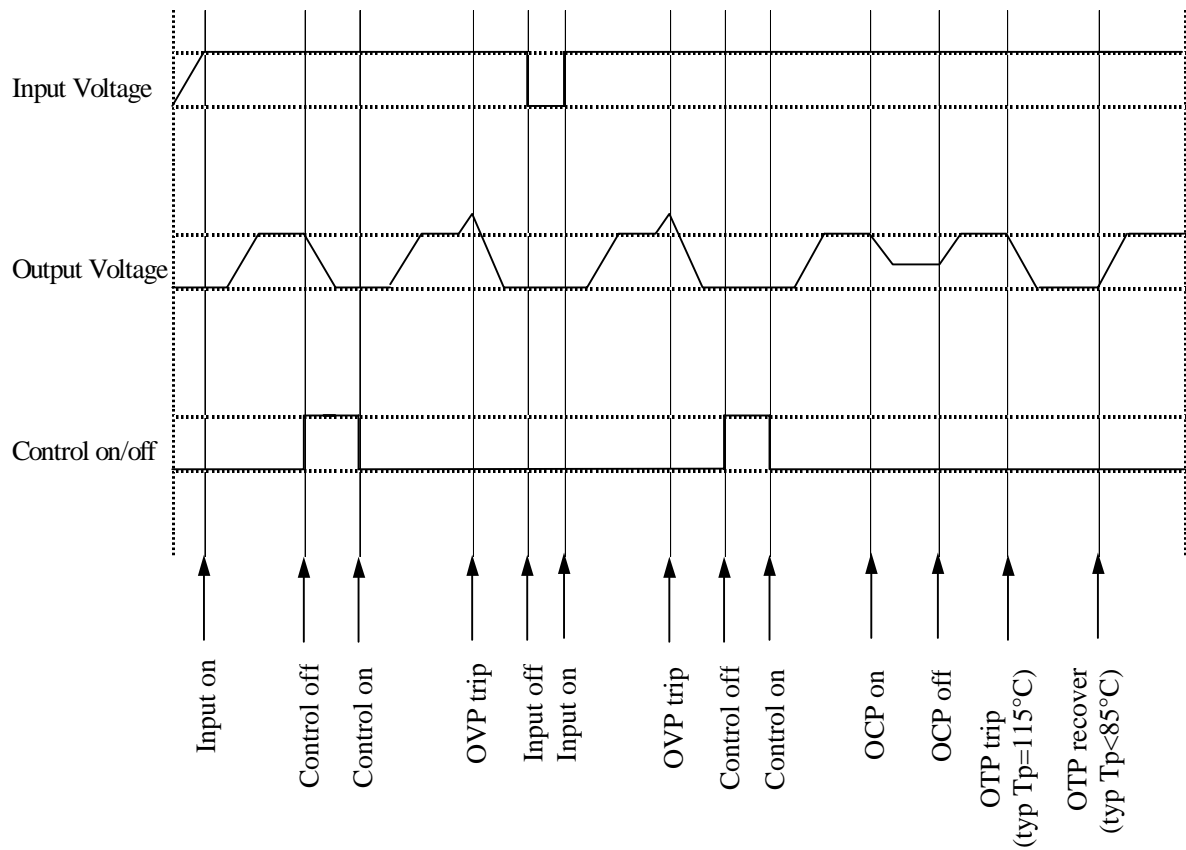
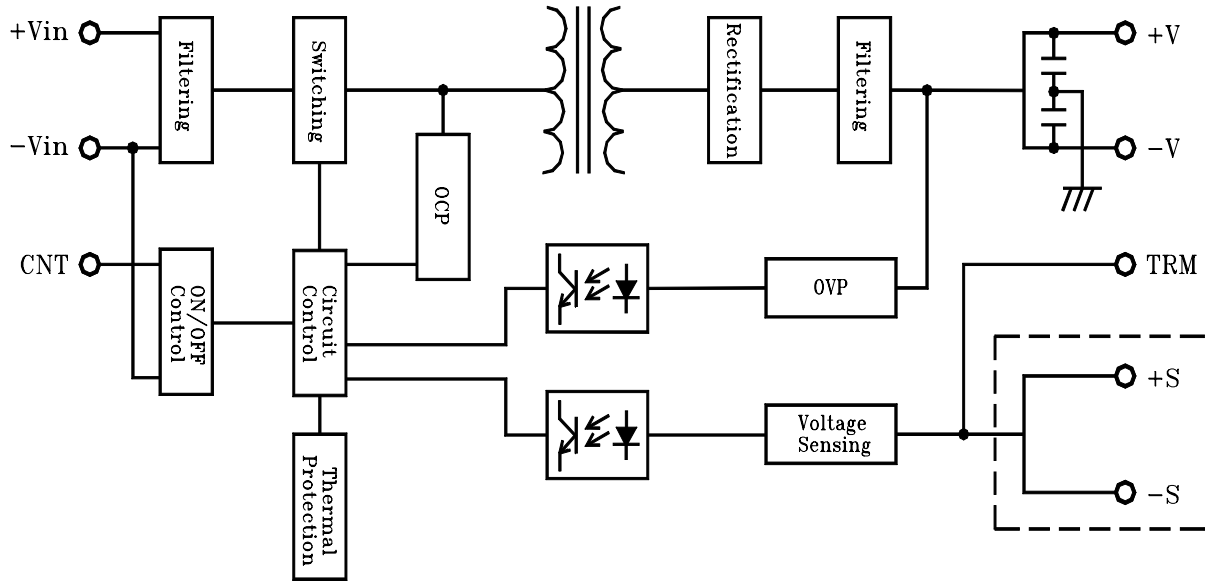

Note : This timing diagram is for Negative Logic "ON/OFF" Option.